

RITTAL GmbH & Co. KG
Auf dem Stützelberg
D – 35745 Herborn
eMail: Info@rittal.de
<http://www.rittal.de>
Service -Tel. : (+49) - (0)2772 / 505 - 0
Service - Fax : (+49) - (0)2772 / 505 - 2319



Installation and Operating Instructions



CE

Drawing Number: A33232_01_IT74

PDM Power Distribution Module
DK 7857.320 / .350

- Status 11 November 2004 -

We reserve all rights in this technical documentation. Without our previous consent it must neither be multiplied nor made available for third parties. Neither must it be abusively utilised any other way by the receiver or third parties. Any violation of the above obliges the violating party to pay compensation and may lead to penal action.

Contents

- 0. Introduction**
- 1. Safety instructions**
- 2. Demands on personnel engaged in installation and operation**
- 3. PDM Power Distribution Module**
 - 3.1. Configuration of PDM
 - 3.1.1. PDM in PDR
 - 3.1.2. PDM in 19" racks
 - 3.2 **Scope of supply**
- 3.3 Technical specifications**
- 4. Functions**
 - 4.1. PDM
 - 4.2. **Wiring diagram**
- 5. Installation**
 - 5.1. Installation in PDR
 - 5.2. Installation PDM
 - 5.3 Installation in enclosure with 19" mounting angles
 - 5.4 Connections to the PSM
 - 5.5 Features to be observed
- 6. Commissioning**
- 7. Operation**
- 8. Maintenance**
- 9. Cleaning**
- 10. Disposal**
- 11. Service and service address**

0. Introduction

The stable flow of information and production is the 'lifeline' of an enterprise. Loss of data, failure of function and production are causing extensive and in many cases life-threatening damage. Therefore, it is the declared company objective to ensure a maximum of safety and reliability.

RITTAL is offering the support to achieve this: By means of universal competence in effective prevention, comprehensive safety, and centralised organisation, i.e. teamwork for IT safety and reliability! This results in optimum combination of power management and administration, enclosure monitoring, server administration and climate control components.

The solution for power management is RITTAL PDR and PDM. This concept includes complete power distribution of the enclosure, i.e. power supply, distribution and protection.

The system is made complete by its sophisticated modular structure. Basic installation can be implemented in next to no time. When the demands on the system increase expansion is easy by means of Power Distribution Modules (PDM).

Power Distribution Rack (PDR) and Power Distribution Module (PDM) provide a revolutionary energy management for IT racks. The modular power supply system allows for energy supply from the 250A infeed through up to 8 plug-in Power Distribution Modules (PDM).

The PDR is destined exclusively for operation in the data centre. From one PDM up to 4 racks with 3 phases per 16 A each can be supplied. The electric current should be distributed in the racks preferably via a PSM busbar.

The PDM is supplied with power via the PDR. For this, the PDM is to be inserted into a vacant module slot of the PDR, as described in Section Installation.

RITTAL **PDM** (Power Distribution Module):

- Sheet steel enclosure 19" 3 U 230 mm deep
- Distribution of 3 phases per 63A via 4 plug-in outlets 3/N/PE AC
- Independent protection of each phase and outlet
- All connections pluggable



1. Safety advice

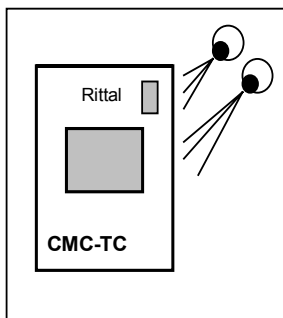

General notes

The installation and operating instructions contain basic information for installing, putting into operation, and operating the RITTAL PDM. It is a must to make the instructions available to the installation technician and the administrative operating personnel and that they should read these carefully. RITTAL cannot accept liability for personal injury and material damage resulting from non-observance of the safety advice in the installation and operating instructions. **It is essential to observe not only the general safety advice given in this chapter, but also the special safety advice given in the other chapters.**

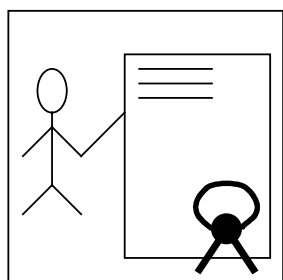

Personnel qualification and authorisation

Operation and any changes may be carried out only by authorised specialist personnel or by authorised trained operating personnel.

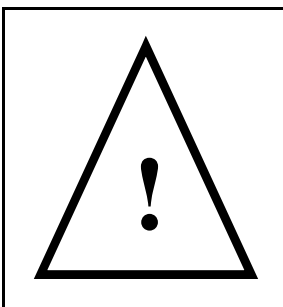

Risks due to non-observance of safety advice

Non-observance of the safety advice may result in risks for the personnel, as well as to the RITTAL PDM together with the connected equipment. Non-observance of the safety advice leads to the loss of the right to claim for any and all damages.

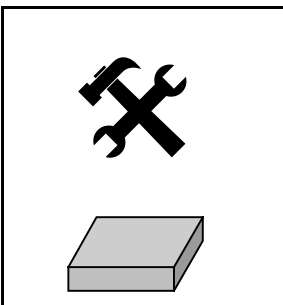

Working on the PDM

The generally applicable electrical regulations of the country in which the unit is installed and operated must be observed, as well as the existing national regulations for the prevention of accidents and any existing internal rules (work, operating, and safety regulations) of the operator. Prior to working at the unit, it must be disconnected from the supply and secured against reconnection. Original accessories and accessories authorised by the manufacturer ensure safety. The use of other parts may void the liability for resulting consequences. Repair work on the PDM may be done only by RITTAL or by authorised personnel.

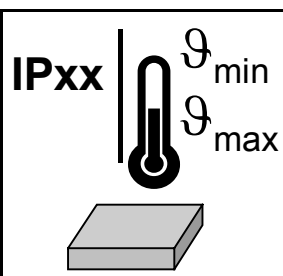

Operating reliability

The operating reliability of the product supplied is warranted only if used as intended. The limit values quoted in the technical data (see Section 3.3 **Technical specifications**) must not be exceeded under any conditions. This applies particularly to the allowed ambient temperature range and the allowed IP protection category. For applications with a higher specified IP protection category, the PDM must be installed in an enclosure or cabinet of a higher IP protection category, which complies with the specified protection category. Operation of the PDM system in direct contact with water, aggressive media, or inflammable gases or fumes is prohibited.

In addition the following points must be observed

- Existing safety devices must not be deactivated.
- The RITTAL PDM may be operated only with protective earth conductor. The PE conductor connection is made by connection in the PDR via the infeed. For this, the connection cable must be connected on the mains-side with the PE conductor.
- The electrical connection voltage must correspond with the rated values specified on the rating plate and/or in Section 3.3 **Technical specifications**.
- Prior to working on the RITTAL PDM this must be disconnected from the supply and secured against reconnection.
- The Rittal PDM must not be manipulated in any way. Internal wiring and connections produced by the manufacturer must not be changed!!!

2. Demands on personnel engaged in installation and operation

Below are extracts quoted from VDE 1000 Part 10.

Skilled electrician

A skilled electrician is a person who is able to judge the work he has to do and to recognise possible risks on the basis of technical training, knowledge, and experience and knowledge of the applicable standards.

The conditions for this are given, amongst others, after training in a recognised occupation to become a skilled worker in electro-technics.

Such persons are allowed to install the infeed from the main distribution to the PDR. Making changes at the PDR and the PDM is restricted to this category of persons. In this context also the conditions of guarantee must be observed.

Work reserved to these persons is specially marked in the above installation and operating instructions.

Person instructed in electro-technics

These persons are instructed by a skilled electrician in respect of the necessary protective equipment and safeguarding measures. In addition, they are instructed on the possible hazards of inappropriate behaviour and are trained for the particular work if necessary.

It is necessary for the person instructed in electro-technics to take notice of and to understand the installation and operating instructions.

The opening of housings or removal of casings as well as making of cable terminal connections are exclusively reserved for skilled electricians.

The activities are restricted to operating the PDM and its connection by connecting cables exclusively by means of connectors.



3. PDM Power Distribution Module

3.1 Configuration of PDM

The Rittal PDM can be installed in the PDR, directly by insertion into the given pitch pattern, or also in existing 19" racks.

3.1.1 PDM in PDR

The modules can be inserted in a vacant position in the given pitch pattern into the PDR. The PDM is to be secured by means of the 4 screws in the 19" profile.

The modules are locked in position by means of a cam lock connected to the main switch. Release is possible only after unlocking by switching off the main switch. Now, the module can be taken out by unscrewing the screws in the 19" profile.

The power supply of the module in the PDR is effected by means of connectors which are making contact when the PDM is inserted in the PDR.

3.1.2 PDM in 19" racks

When the PDM is installed in any type of 19" system or enclosure the module must be supplied with power in an appropriate manner from the main distribution or from a CEE socket. This is to be implemented via the separately available PDM connection cable.

The PDM connection cable has Article No. 7857.351.

Pay attention to back-up fuse!! See notice on rating plate.

Cable clamping and protection is made by means of the enclosed cable clamp strap at the casing or enclosure used.

3.2 Scope of supply

PDM Power Distribution Module

DK7856.320

19" 3 U subrack

ABB main switch OT63 with 63A switching capacity

12x ABB power circuit breaker 16A

DK7856.350 (project-related)

19" 3 U subrack

ABB main switch OT63 with 63A switching capacity

12x ABB power circuit breaker 16A

ABB 63A RC circuit breaker



3.3 Technical specifications

PDM	19" enclosure 3U
Depth	approx. 220mm
Weight	approx. 25kg without packaging
Potential equalisation	Yes
Earthing	Yes
IP protection category	IP 20 as per EN 60529
Operating temperature range:	+ 5 °C to 45 °C/+ 41 °F to 113 °F
Operating humidity range	5 % to 95 % relative humidity, non-condensing
Storage temperature range	-20 °C to 60 °C/ - 4 °F to 140 °F
Voltage connection:	
Power supply	Infeed: 3/N/PE AC 400/230V, max. current 63A
Fusing	Back-up fuse by client; please, observe rating plate!
Infeed:	Number of poles: L1, L2, L3, N, PE Connector: 4-pole + PE Rated voltage EN [V]: 400 Rated surge voltage resistance [KV]: 2.5 Rated current [A] : 63 Short-circuit current [kA]: 10
General:	Level of contamination: 2 Internal compartmentalisation: Form 4b (EN 60439-1 Sect. 7.7) EMC environment 1 (EN 60439-1 Sect. 7.10)

4. Functions

The focus of the scope of functions of the Rittal PDM is on the distribution of electric power inside a data centre from the main distribution to the PSM busbars in the racks or distribution of the electric power from the PDR.

4.1 PDM

Through a PDM up to 4 inputs of the Rittal busbar PSM with 3 phases 400/230V per 16A can be supplied. By using ready-made connection cables these PSM can quickly and easily be connected with the PDM.

Optionally, an RC circuit breaker can be installed (Article No.: 7857.350). This RC circuit breaker switches off the complete PDM.

Note:

Because of the EMC discharge via the PE conductor, originating from the electronics devices installed in the data centre, there are currents in the PE conductor during normal operation that cause the RC breaker to trip.



4.2 Wiring diagram

Key:

Entfällt bei
PDR 7857.310 =
Not with PDR 7857.310

Leistungsschalter
3-polig, 250A =
Power circuit breaker
3-pole, 250A

Einspeisung =
Infeed

Anschlüsse für PDM =
Connections for PDM

Anschlüsse für PDM =
Connections for PDM

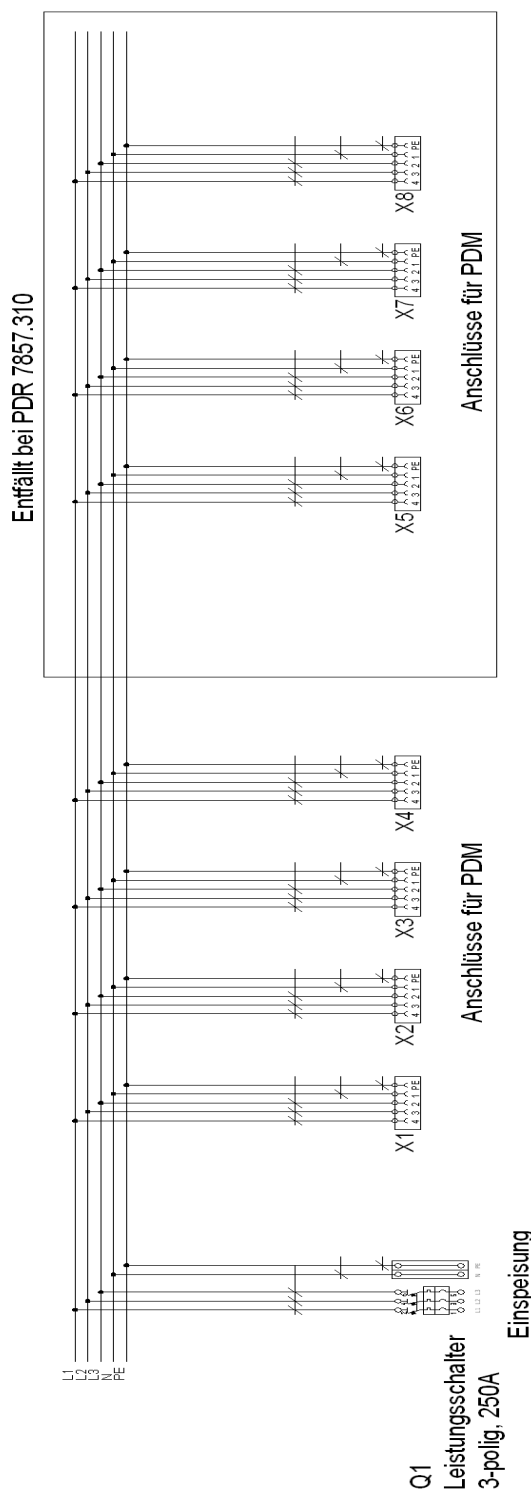

5. Installation

- The RITTAL PDM system is to be put up in racks in the data centre where it is reliably protected from external influences.
- Attention must be paid to maintaining the allowed ambient temperature and humidity ranges, as well as the IP protection category as required for the specific application. The appropriate information is given in Section 3.3 **Technical specifications**.
- **When using accessories in connection with the RITTAL PDR / PDM the installation and operating instructions for the accessories and for the RITTAL PDR / PDM must be observed.**
- **The PE conductor is connected through the connector of the infeed.**
- **When the PDM is installed in a 19" rack the PE conductor must be connected using this cable.**

5.1. Installation in PDR

The slide rails which are part of the accessories are to be attached at the intended module slot location in the PDR. The PDM is then inserted into this module slot in switched-off condition. The screws included in the accessories are used to fasten the PDM to the 19" mounting angles.

5.2 Installation PDM

Einbau im 19" Rack's/ Intallation into 19" Rack's

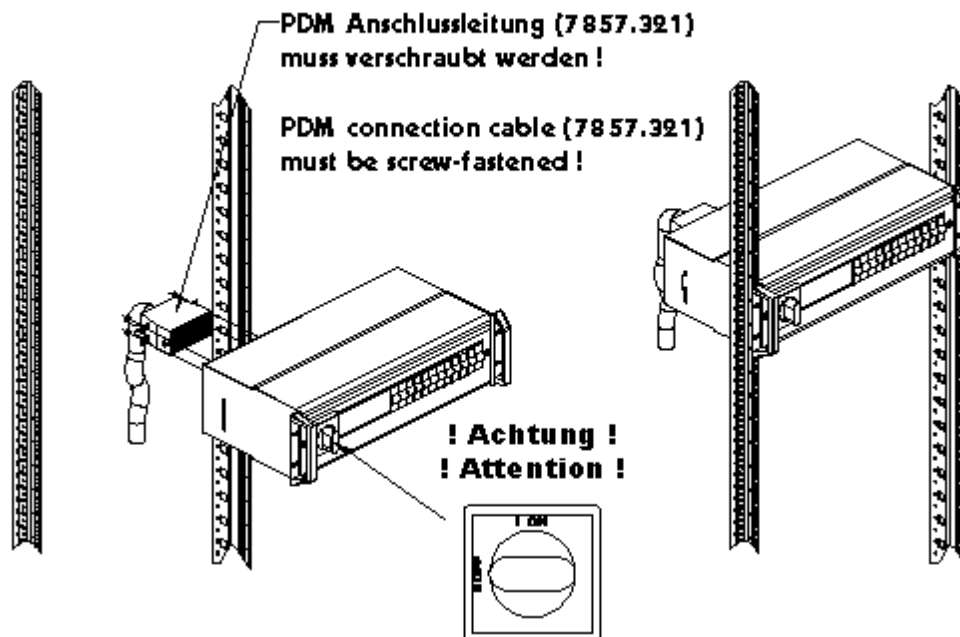

Einbau im PDR/ Intallation into PDR 7857.300 / .310

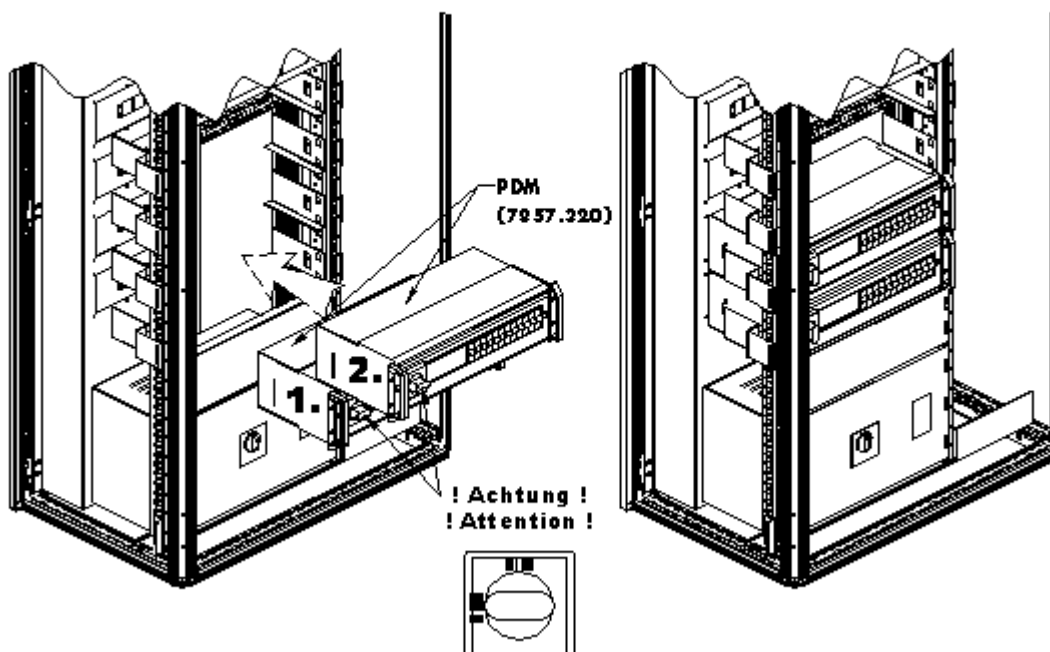

5.3 Installation in enclosure with 19" mounting angles

The PDM is fastened in the 19" pitch pattern with the screws included in the accessories. It is recommended to use slide rails Model number DK 7063.000 for supporting the PDM casing.

If power supply is to be made via a CEEkon socket, the connection cable DK 7857.351 must be used.

The fuse as specified on the rating plate must be used.

The infeed cable may be unplugged or plugged in only with the PDM switched off. The connector must be secured against unplugging by means of the two clamps included in the accessories. The nuts must be tightened securely using a tool.

5.4 Connections to the PSM

Following installation of the PDM the connection cables to the power strips or to other consumers can be laid. When using ready-made connection cables a skilled electrician (see Section 2) is not required.

5.5 Features to be observed

Note: During installation the existing national and regional regulations of the country, in which the RITTAL PDR or PDM are to be installed and/or operated, must be observed!

- **Attention: Danger to life, the following points must always be observed:**
No objects must be inserted into the sockets of the modules because high electrical voltage must be expected which can cause danger to life.
Attention Voltage! Danger to Life!
- A device operated in connection with the RITTAL PDM must always be isolated (dead), for instance by switching off and disconnecting the mains connection line, prior to any maintenance and repair work.

6. Commissioning

Prior to commissioning a PDM one must check in each connected rack whether there is work being done at the electrical system or whether parts carrying dangerous voltage can be contacted. When voltage is switched on without making a check there is a risk of electric shock occurring when work is being done at the connected electrical system.

The power line to the infeed must also be checked for safe condition.

All main switches and automatic circuit-breakers of the plugged-in PDM must be switched off.

By switching on the main switch the PDM is connected to voltage.

The main switches of the PDM are then also switched on.

After that the automatic circuit-breakers are to be switched on.

Between the individual switching operations it must be checked whether any extraordinary reactions occur in the connected units concerning rising temperatures or increased voltage of accessible parts.

Circuit diagram and description of connections must be placed in the wiring plan pocket of the PDR or in the rack.

7. Operation

Tripped fuses may be switched on again during continued operation. Prior to that, one must find out why the fuse had tripped. The cause for tripping, short-circuit or overload, must be eliminated before switching on again.

In addition one must check before reconnection whether there are persons working at the switched-off outputs or if voltage-carrying parts are accessible.

8. Maintenance

The **RITTAL PDM** is a maintenance-free system. The casing may be opened by a skilled electrician (see Section 2) for inspection only. When the casing is opened all warranty and liability claims will become void.

9. Cleaning

The RITTAL PDM can be cleaned using a dry cloth. The use of aggressive substances like cleanser's solvent, acids, etc. will cause corrosion of the system.



10. Disposal

Because the RITTAL PDM is consisting mainly of steel, copper, and plastic material the unit must be submitted to proper disposal when it is no longer required. The infeed cables must be cut in case of disposal.

11. Service and service address

If you have any questions concerning technical or other issues related to our product range RITTAL will of course support you. You may contact us also by e-mail using the information indicated below.

RITTAL GmbH & Co. KG
PM IT-Service
Auf dem Stützelberg

D-35745 Herborn
1 Germany

<http://www.RITTAL.de>

Email: **Info@RITTAL.de** **Attention: Please, always indicate the item number in the reference line!**

Phone: +49 (0)2772/505-0
Fax: +49 (0)2772/505-2319

For further information on RITTAL PDR and PDM units please visit our internet homepage.

